



Safe and approved storage of flammable liquids and further hazardous substances

Function / construction:

Cabinet body

- **Robust construction and longevity:** triple hinged door, safety elements assembled outside the storage compartment for increased protection against corrosion, scratch- and impact-resistant surface, easy to clean
- **Effortless use:** one-hand operation for double-door cabinets (AGT)
- **User-friendly and safe:** door open arrest system (standard), convenient and safe removal or storage of containers
- **Always closed:** serial automatic door closing (TSA) releases arrested doors after approx. 60 seconds; acoustic and visual signal before closing
- **No unauthorised use:** doors lockable with cylinder locking (integration in an existing locking

system possible) and locking state indicator (red/green)

- **Easy transport:** integrated transport base with removable, optional base cover
- **Easy alignment:** adjusting aids to compensate for uneven floor

Recirculating air filter system

- Ideal for the direct installation in working areas – very low noise, only approx. 39 dB (A)
- With multi-stage wideband filter
- Monitoring electronics for extraction and filtration incl. cool-device cable and power plug
- Optical and acoustical alarm including potential-free alarm contact
- Display with innovative touch panel
- ATEX compliant: **CE** II 3/-G Ex ic nA IIB T4 Gc

Recirculating air filter storage cabinet
FX-PEGASUS-90 model FX90.229.090.WDAC
 body colour anthracite grey (RAL 7016), with wing doors in traffic red (RAL 3020), interior equipment with 3 x shelf, 1 x perforated insert, 1 x bottom collecting sump (sheet steel powder-coated)
Order No. 32910-046-33622 (base cover optional)



Available equipment:

- Drawers – high storage capacity, optimal use of the available storage capacities
- Sump inliner (PE or PP)
- Shelves with load capacity of 75 kg
- Storage box
- Perforated insert useable as storage area
- Metal-free tray shelves and collecting sumps
- Drawers heavy-duty with load capacity of 100 kg
- Tray shelves with load capacity of 150 kg
- Bottom collecting sump



Reusable filter system

Multistage, high-capacity and robust broad band-pass filter, environmentally friendly due to long service lifetimes and filter recycling



Easy operation

Monitoring electronics with state-of-the-art 4.7" graphic display incl. touch panel, displays all essential monitoring-details



Extraction and filtration

Filtration of solvent vapours (hydrocarbons) as well as inorganic and organic hazardous materials



Manual test device

Easy monitoring of the filter saturation when storing inorganic substances



Recirculating air filter storage cabinet

FX-PEGASUS-90 model FX90.229.090.WDAC

body colour anthracite grey (RAL 7016), with wing doors in light grey (RAL 7035), interior equipment with 4 x drawer (sheet steel powder-coated)

Order No. 32910-041-33627

(base cover optional)



Recirculating air filter storage cabinet

FX-PEGASUS-90 model FX90.229.090.WDAC

body colour anthracite grey (RAL 7016), with wing doors in warning yellow (RAL 1004), interior equipment with 6 x drawer (sheet steel powder-coated)

Order No. 32910-040-33629

(base cover optional)

3 door colours are available at no extra cost:



040 041 046

Order example - how to order correctly



32910 - 040 - 33623

Model	Information / equipment	Order No.
FX90.229.090.WDAC	without interior equipment, with TSA, AGT, door open arrest system	32910

Body colour	Door colour	Order No.
Anthracite grey RAL 7016	warning yellow RAL 1004	040 6
Anthracite grey RAL 7016	light grey RAL 7035	041 6
Anthracite grey RAL 7016	traffic red RAL 3020	046 6















































Interior equipment packages (can only be ordered in combination with the cabinet)	Material	Order No.
3x shelf, 1x perforated insert, 1x bottom collecting sump (V=22.0L)	sheet steel powder-coated RAL 7035	33622 2
4x shelf, 1x perforated insert, 1x bottom collecting sump (V=22.0L)	sheet steel powder-coated RAL 7035	33623 2
3x shelf, 1x bottom collecting sump (V=22.0L)	sheet steel powder-coated RAL 7035	33624 2
4x shelf, 1x bottom collecting sump (V=22.0L)	sheet steel powder-coated RAL 7035	33625 2
3x shelf, 1x perforated insert, 1x bottom collecting sump (V=22.0L)	stainless steel	30047 2
4x shelf, 1x perforated insert, 1x bottom collecting sump (V=22.0L)	stainless steel	30048 2
3x shelf, 1x bottom collecting sump (V=22.0L)	stainless steel	30049 2
4x shelf, 1x bottom collecting sump (V=22.0L)	stainless steel	30050 2
3x tray shelf (V=22.0L), 1x bottom collecting sump (V=22.0L)	PP grey	30051 2
4x tray shelf (V=22.0L), 1x bottom collecting sump (V=22.0L)	PP grey	30052 2
4x drawer (V=19.0L)	sheet steel powder-coated RAL 7035	33627 2
5x drawer (V=19.0L)	sheet steel powder-coated RAL 7035	33628 2
6x drawer (V=19.0L)	sheet steel powder-coated RAL 7035	33629 2
4x drawer (V=19.0L)	stainless steel	33631 6
5x drawer (V=19.0L)	stainless steel	33632 6
6x drawer (V=19.0L)	stainless steel	33633 6



Individual configuration of model **FX90.229.090.WDAC**

 Model	Information / equipment	W x D x H (mm)	Order No.
FX90.229.090.WDAC	without interior equipment, with TSA, AGT, door open arrest system	893 x 615 x 2294	32910

 Body colour	Door colour	Order No.
Anthracite grey RAL 7016	traffic red RAL 3020	046 
Anthracite grey RAL 7016	warning yellow RAL 1004	040 
Anthracite grey RAL 7016	light grey RAL 7035	041 

 Interior equipment	Material	W x D x H (mm)	 ¹⁾	 ²⁾	 ³⁾	Order No.	
Shelf							
 Shelf	sheet steel powder-coated RAL 7035	740 x 432 x 30*	75.00			30059 	
	stainless steel	740 x 432 x 30*	75.00			30061 	
 Tray shelf	sheet steel powder-coated RAL 7035	725 x 445 x 80*	150.00	23.50	21.36	30828 	
	stainless steel	723 x 488 x 83*	150.00	22.00	20.00	30829 	
 Tray shelf metal-free	PP grey	644 x 416 x 102*	50.00	22.00	20.00	30063 	
Perforated insert							
 Perforated insert	sheet steel powder-coated RAL 7035	724 x 417 x 70	75.00			11165 	
	stainless steel	724 x 417 x 70	75.00			11168 	
Bottom collecting sump							
 Bottom collecting sump	sheet steel powder-coated RAL 7035	725 x 445 x 80*		22.00	20.00	33621 	
	stainless steel	723 x 488 x 83*		22.00	20.00	30062 	
 Bottom collecting sump metal-free	PP grey	749 x 505 x 107		22.00	20.00	33829 	
Drawer							
 Drawer	sheet steel powder-coated RAL 7035	544 x 488 x 90*	60.00	19.00	1727	30065 	
	stainless steel	544 x 488 x 90*	60.00	19.00	1727	30067 	
 Drawer (heavy duty)	sheet steel powder-coated RAL 7035	543 x 487 x 162*	100.00	45.00	40.91	30066 	
	stainless steel	543 x 487 x 162*	100.00	45.00	40.91	30068 	
Accessories							
 Storage box left hinged	sheet steel powder-coated RAL 7035	380 x 420 x 360				30029 	
 Storage box right hinged	sheet steel powder-coated RAL 7035	380 x 420 x 360				30030 	
 Sump inliner for drawer	PP grey	534 x 450 x 96*		23.00	20.91	27948 	
 Sump inliner for shelf	PP grey	653 x 406 x 88*		21.50	19.55	9707 	
 Anti-slip rubber mat for drawer	black	540 x 490 x 1				15653 	
 Pipe lead-through	sheet steel powder-coated RAL 7035	182 x 104 x 48				30035 	
 Base cover	sheet steel powder-coated textured RAL 7016	818 x 35 x 85				30069 	
 Q-mover 2 pieces	steel powder-coated textured RAL 7016	600 x 140 x 130				30037 	
 Box for chemicals	PP blue	410 x 300 x 260				30038 	
 Document holder DIN A5	polystyrene					30793 	

* usable storage space W x D (mm)

1) load capacity (kg), 2) retention capacity (ltr), 3) maximum container volume in the cabinet (ltr)

Activated carbon replacement filter
with multistage filter system
Order No. 32950 



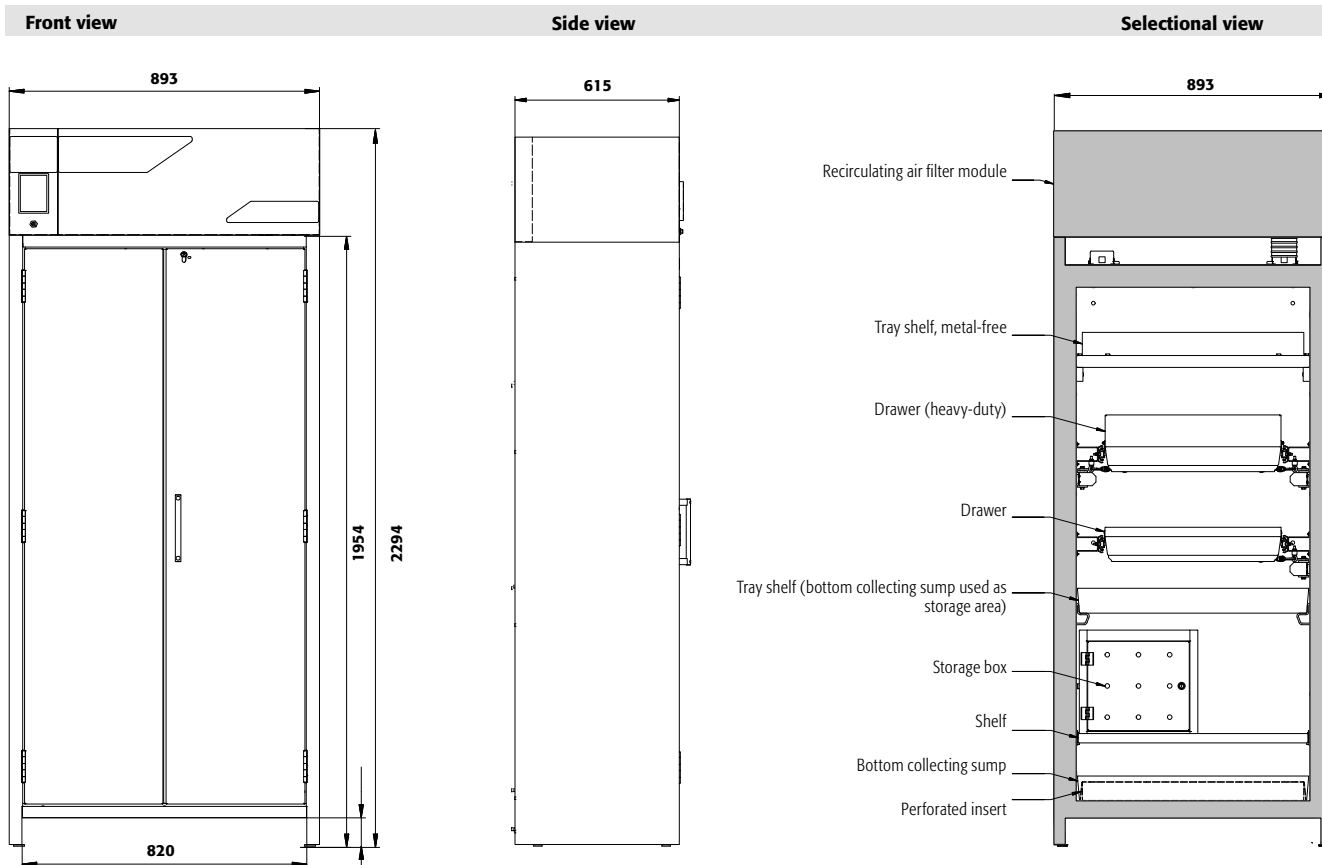

Technical data

External dimensions W x D x H
 Internal dimensions W x D x H
 Weight without interior equip.
 Distributed load
 Maximum load
 Frequency
 Nominal voltage
 Max. current consumption
 Power consump. in operation
 Power consump. in standby mode

FX90.229.090.WDAC

mm 893 x 615 x 2294
 mm 750 x 522 x 1647
 kg 370
 kg/m² 667
 kg 600
 Hz 50
 V 230
 A 0.5
 W 120
 W 50

Transport base

Entry height transport base
 Entry width transport base

mm 90
 mm 820

Top view

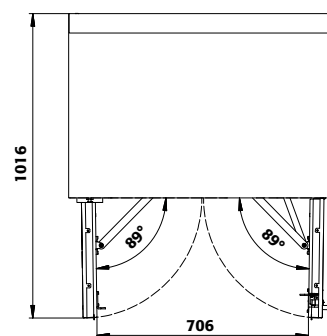

FX90.229.090.WDAC

Drawers/number

	9	8	7	6	5	4+1	4	3+1	3	2
Distance ⑨ (mm)	150									
Distance ⑧ (mm)	135	150								
Distance ⑦ (mm)	135	170	150							
Distance ⑥ (mm)	135	170	200	250						
Distance ⑤ (mm)	135	170	200	230	280	250				
Distance ④ (mm)	135	170	200	230	295	230	345			
Distance ③ (mm)	135	170	200	230	295	230	360	440		
Distance ② (mm)	170	170	200	230	295	230	360	520	920	
Distance ① (mm)	230	230	265	265	295	520	425	550	615	

Standard storage heights of the drawers

FX90.229.090.WDAC

Shelves/number

	4	3	2
Distance ④ (mm)	370		
Distance ③ (mm)	285	400	
Distance ② (mm)	315	380	
Distance ① (mm)	315	410	

Standard storage heights of the shelves

FX90.229.090.WDAC

Quantity

Quantity	Type of container	Container size
49	Aerosol cans	400 ml
23	Cans	1 litre
23	Laboratory glass bottles	1 litre
23	Laboratory PE-bottles	1 litre
9	Laboratory glass bottles	2.5 litres

Storage capacities per drawer/type of container

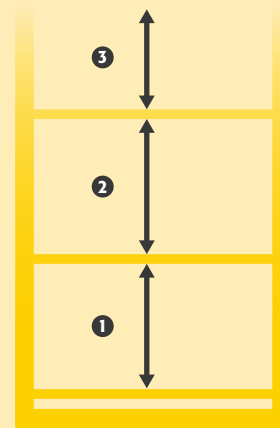

SLX
CX