

AdvancelabPro® Steel

CASEWORK



Our Story

Island

Bench

Ergonomics

Construction

Cut Sheet

Palette

Accessories

Taps

Reagent Rack

Electric Sockets

Safety Equipment

Dilution Tank

Worktop



A South-East Asian and beyond **MANUFACTURER** with HQ in Singapore and manufacturing base in Malaysia.

Our DNA consists of forward thinking designs, **FLEXIBLE** layouts and creativity.

We are **EXPORTING** to all continents and count more that 40 regular distributors who have been with us for years.

We build the correct **RELATIONSHIPS**.

Our large range of manufacture include everything from pass boxes to cleanbooths, allowing us to give **SOLUTIONS** across the board.



**PEOPLE
COMPANY
PRODUCTION
COUNTRY**

from
SINGAPORE
to the
world



Island



Bench



Ergonomics

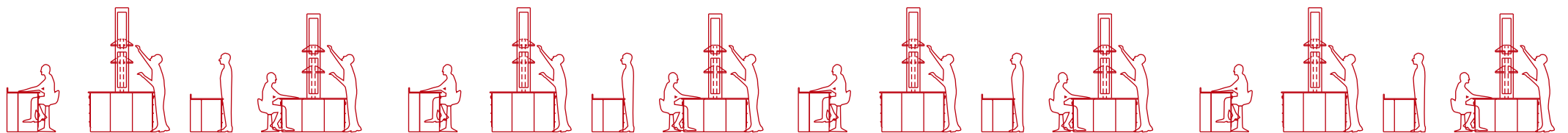
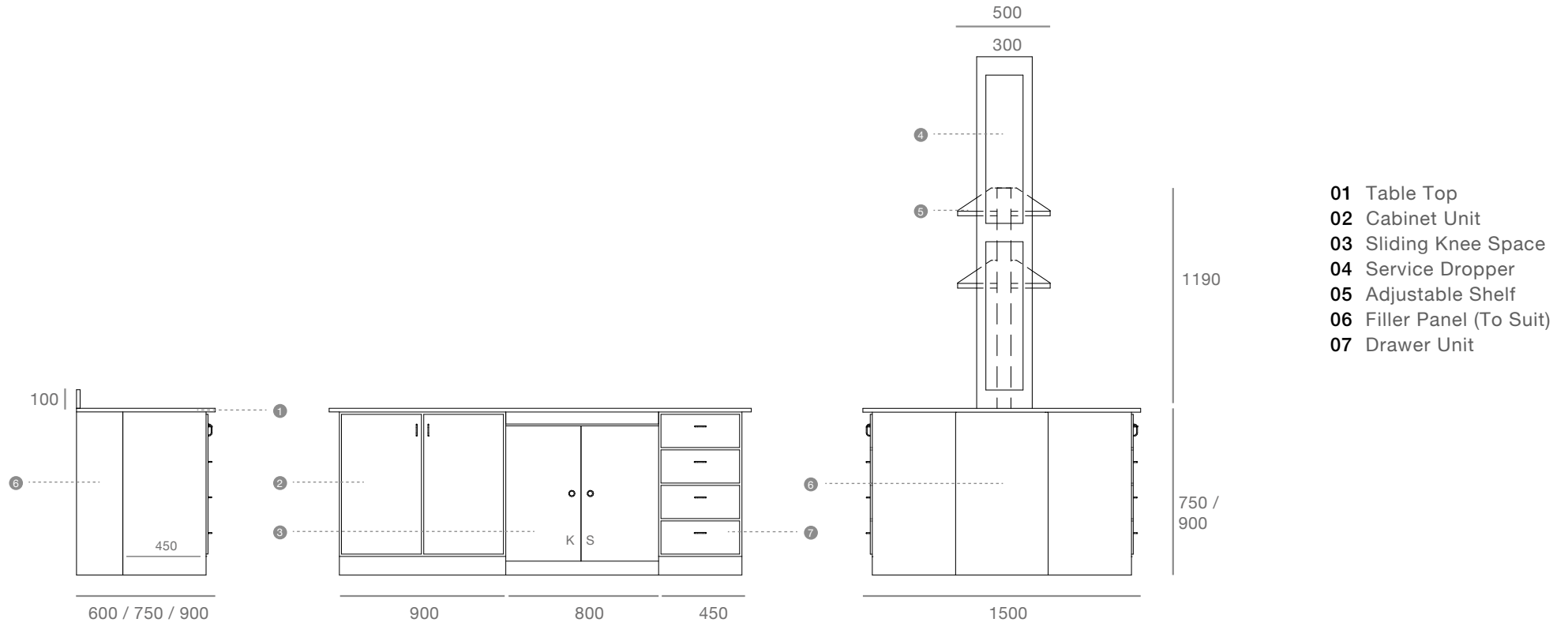

Construction

FLEXIBILITY - standard modules of 450 and 900 mm allow us to set up a lab and easily reconfigure it to suit future needs.

LONG LASTING electrogalvanised steel construction with 1.0 mm thickness with a heavy powder coated finish for a lush look that will last years in robust laboratory environments.

SLIDING KNEE SPACES - this makes it incredibly flexible on site, it can be adjusted at site to suit local construction conditions. A very forgiving set up.

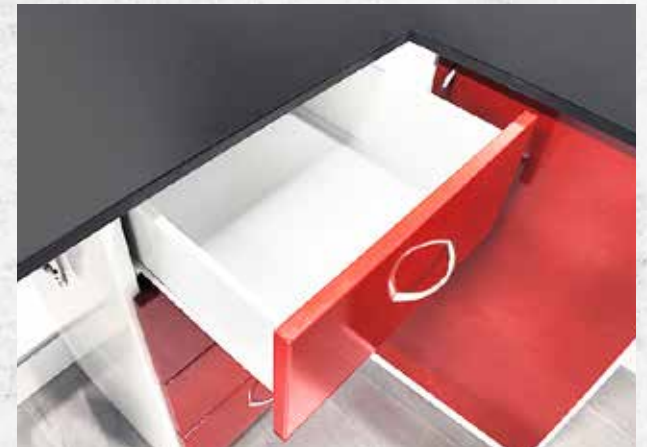

Cut Sheet

Underbench



Sink Cabinet

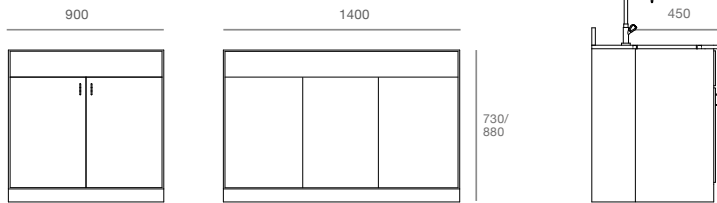

Corner Cabinet

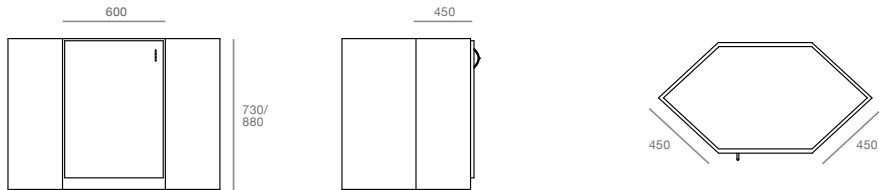

Wall Hung



Palette

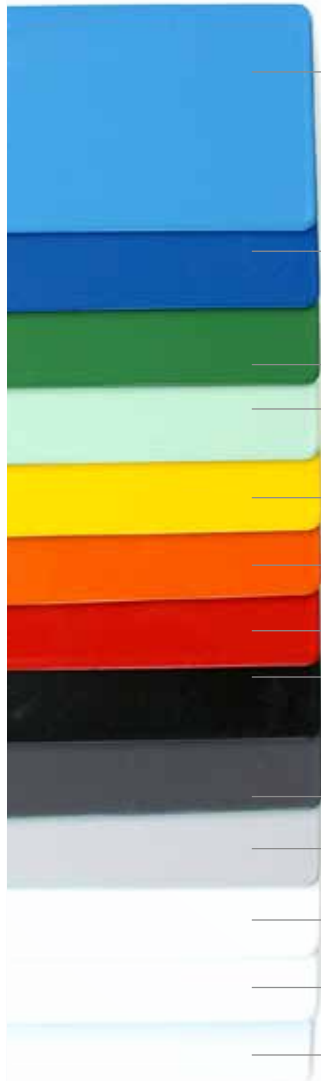

Light Blue
PR12/363/CS21

Ocean Blue
PR12/3106/CS6

Emerald Green
PR12/2045/CS2
Pastel Green
PR12/227/CS13

Signal Yellow
FF160/164/C

Orange
FF160/6178/C4

Traffic Red
PR12/526/CS28

Black
PR12/708/CS

Dark Grey
PR12/892/CS10

Light Grey
PR12/808/CS10

Cream
PR12/4249/CS1

White
LB1000

Purple White
FF160/12/C1



Accessories

Taps



1 Way Water Faucet
ADBM104 - 3B1
Bench Mount, Swivel
Neck & Fixed Nozzle.
Weight: 1.18 kg



2 Way Water Faucet
ADBM110 - 3B1
Bench Mount & Fixed
Nozzle.
Weight: 1.45 kg



3 Way Water Faucet
ADBM106 - 5B1
Bench Mount, Swivel
Neck & Fixed Nozzle
Weight: 2.18 kg



1 Way Bench Gas Valve
ADOM010 NG
Lift & Turn Operation &
Fixed Nozzle
Weight: 0.65 kg



2 Way 90° Bench Gas Valve
ADOM020 NG
Lift & Turn Operation &
Fixed Nozzle
Weight: 0.83 kg



2 Way 180° Bench Gas Valve
ADOM025 NG
Lift & Turn Operation &
Fixed Nozzle
Weight: 0.81 kg

Electric Sockets



Single 3-Pin Power Socket
Electric Power
Socket 13A



Twins 3-Pin Power Socket
Electric Power
Socket 13A



AD 450 Drying Rack
High impact Polyethylene
drying rack. The back plate
of the 72 place support is
made from a single mould of
4mm rigid HIPS.
Size: 450mm x 630mm x
110mm

Safety Equipment



Single Bench Mount Eyewash
ADE200SS
Single Nozzle Bench
Spray Unit, Vertical
Extraction (Top Mounting)



Twins Bench Mount Eyewash
ADE300SS
Twins Nozzle Bench
Spray Unit, Vertical
Extraction (Top Mounting)

Reagent Rack

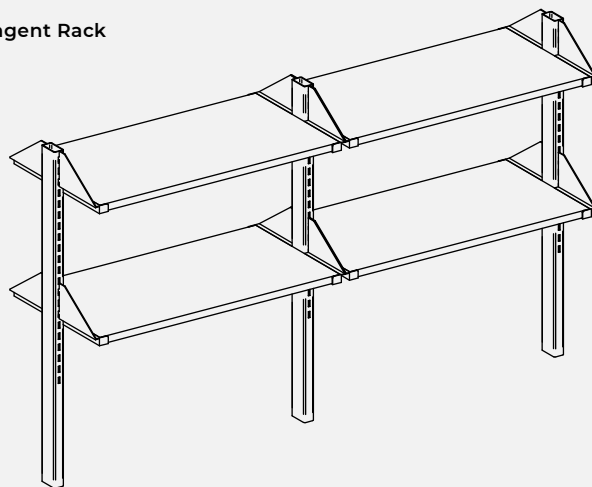

Worktops

	Type	Thickness	Colour
	Phenolic Resin	16mm (Standard) 25mm	Grey
	Epoxy Resin	19mm (Standard) 25mm	Grey, Black
	Stainless Steel 304 Stainless Steel 316	1.2mm (Standard) 1.5mm	

Dilution Tank



AD250 PPDT
Advancelab dilution tank
made by full polypropylene
construction. Available
in 250mm diameter.
Size: 250mm x 300mm x
250mm





Singapore

Advancelab (S) Pte Ltd

253 Kaki Bukit Ave 1, Singapore 416061
Tel: +65 6448 8255
Fax: +65 6448 9833
Email: info@advancelab.com.sg

Malaysia

Advancelab Sdn Bhd

No. 3388, Jalan Pekeliiling Tanjung 27/2,
Kawasan Perindustrian Indahpura,
81000 Kulaijaya, Johor, Malaysia.
Tel: +607 660 8877
Fax: +607 660 8866
Email: info-my@advancelab-global.com

Myanmar

Advancelab Scientific & Engineering Co., Ltd

No.(976/Ka), Than Thu Mar Road,
5th Ward, South Okkalapa Township,
Yangon, Myanmar.
Tel: +95 (1) 572393 / +95 (9) 779753802
Fax: +95 (1) 572393
Email: info-mm@advancelab-global.com

Indonesia

PT Advancelab Saintifik

253 Kaki Bukit Ave 1, Singapore 416061
Tel: +65 6448 8255
Fax: +65 6448 9833
Email: info@advancelab.com.sg

Vietnam

M&T International Trading Services Co., Ltd

46A Phan Dinh Phung, Tan Thanh Ward,
Tan Phu District, Ho Chi Minh City
700000, Vietnam.
Tel: +84 28 6656 0610
Email: info@advancelab.com.sg

Thailand

Prima Scientific Co., Ltd.

147 / 170 - 171 Baromrajchonnane Road,
Arunamarin Bangkoknoi, Bangkok 10700,
Thailand.
Tel: +66 2 884 9480
Fax: +66 2 884 6441
Email: primasci@primasci.com

U.A.E (Dubai)

Advancelab FZCO

No.FZJOAB1310 Jafza One, Jebel Ali
Dubai, United Arab Emirates
Email: info@advancelab.com.sg