



Safety storage cabinet
S-CLASSIC-90 model S90.196.120
 warning yellow (RAL 1004), interior equipment with 3 x shelf,
 1 x perforated insert, 1 x bottom collecting sump (sheet steel powder-coated)
Order No. 30115-002-33715
 (recirculating air filter system optional)



Safe and approved storage of flammable hazardous substances in working areas

Function / construction:

- **Robust construction and longevity:** triple hinged door, body made of powder-coated sheet steel, safety elements assembled outside the cabinet for increased protection against corrosion
- **User-friendly and safe (model .WDAS):** door open arrest system, convenient and safe removal or storage of containers
- **No unauthorised use:** doors lockable with profile cylinder (integration in an existing locking system possible)
- **Easy alignment:** adjusting aids to compensate for uneven floor

- **Ventilation:** integrated air ducts ready for connection (DN 75) to a technical exhaust system

Available equipment:

- Drawers – high storage capacity, optimal use of the available storage capacities
- Sump inliner (PE or PP)
- Shelves with load capacity of 75 kg
- Storage box
- Perforated insert useable as storage area
- Metal-free tray shelves and collecting sumps
- Drawers heavy-duty with load capacity of 100 kg
- Tray shelves with load capacity of 150 kg
- Bottom collecting sump



Are you familiar with the Q-LINE?
 An integrated transport base enables maximum flexibility when choosing the installation location.

Further information from page 64

Drawers
 High storage capacity
 Ideal for the storage of small containers

Extraction unit with exhaust air monitoring
 Safe ventilation of safety storage cabinets

Plug-in – fast and easy to install

Further information and products from page 505

Order No. 14220

Metal-free interior equipment
 Ideal for the storage of flammable, aggressive hazardous substances. Tray shelves with chemical resistant surface lamination and removeable plastic sump, bottom collecting plastic sump.

The ascos HazMat Guide
 ... we have collected the most important information on storing and handling hazardous materials safely.
 Order your free copy now:
www.ascos.global

Recirculating air filter system
 Avoid complex wall break-throughs and expensive extraction piping
 Further information from page 500

Order No. 25099



Safety storage cabinet
S-CLASSIC-90 model S90.196.120.WDAS
 warning yellow (RAL 1004), interior equipment with 4 x drawer (sheet steel powder-coated)
Order No. 30116-002-33724
 (extraction unit optional)

Safety storage cabinet
S-CLASSIC-90 model S90.196.120.WDAS
 light grey (RAL 7035), interior equipment with 6 x drawer (sheet steel powder-coated)
Order No. 30116-001-33726

Available colours:



PLEASE NOTE: interior equipment with drawers can only be ordered in combination with WDAS cabinets

Order example - how to order correctly



Model	Information / equipment	Order No.
S90.196.120	without interior equipment	30115
S90.196.120.WDAS	without interior equipment, with door open arrest system	30116

Body colour	Door colour	Order No.
Light grey RAL 7035	light grey RAL 7035	001
Warning yellow RAL 1004	warning yellow RAL 1004	002
Laboratory white (sim. RAL 9016)	laboratory white (sim. RAL 9016)	005





















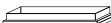



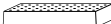





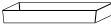







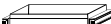

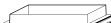







Interior equipment packages (can only be ordered in combination with the cabinet)	Material	Order No.
3x shelf, 1x perforated insert, 1x bottom collecting sump (V=33.0L)	sheet steel powder-coated RAL 7035	33715
4x shelf, 1x perforated insert, 1x bottom collecting sump (V=33.0L)	sheet steel powder-coated RAL 7035	33716
3x shelf, 1x bottom collecting sump (V=33.0L)	sheet steel powder-coated RAL 7035	33717
4x shelf, 1x bottom collecting sump (V=33.0L)	sheet steel powder-coated RAL 7035	33718
3x tray shelf (V=33.0L), 1x perforated insert, 1x bottom collecting sump (V=55.0L)	sheet steel powder-coated RAL 7035	33719
3x shelf, 1x perforated insert, 1x bottom collecting sump (V=33.0L)	stainless steel	33720
4x shelf, 1x perforated insert, 1x bottom collecting sump (V=33.0L)	stainless steel	33721
3x shelf, 1x bottom collecting sump (V=33.0L)	stainless steel	33722
4x shelf, 1x bottom collecting sump (V=33.0L)	stainless steel	33723
3x tray shelf (V=33.0L), 1x bottom collecting sump (V=33.0L)	PP grey	30143
4x tray shelf (V=33.0L), 1x bottom collecting sump (V=33.0L)	PP grey	30144
4x drawer (V=29.0L)	sheet steel powder-coated RAL 7035	33724
5x drawer (V=29.0L)	sheet steel powder-coated RAL 7035	33725
6x drawer (V=29.0L)	sheet steel powder-coated RAL 7035	33726
4x drawer (V=29.0L)	stainless steel	33727
5x drawer (V=29.0L)	stainless steel	33728
6x drawer (V=29.0L)	stainless steel	33729



Individual configuration of model S90.196.120 / S90.196.120.WDAS

 Model	Information / equipment	W x D x H (mm)	Order No.
S90.196.120	without interior equipment	1196 x 616 x 1968	30115
S90.196.120.WDAS	without interior equipment, with door open arrest system	1196 x 616 x 1968	30116

 Body colour	Door colour	Order No.
Light grey RAL 7035	light grey RAL 7035	001 
Warning yellow RAL 1004	warning yellow RAL 1004	002 
Laboratory white (sim. RAL 9016)	laboratory white (sim. RAL 9016)	005 

 Interior equipment	Material	W x D x H (mm)	 ¹⁾	 ²⁾	 ³⁾	Order No.
Shelf						
 Shelf	sheet steel powder-coated RAL 7035	1040 x 432 x 30*	75.00			30021 
	stainless steel	1040 x 432 x 30*	75.00			30024 
 Tray shelf	sheet steel powder-coated RAL 7035	1022 x 442 x 80*	150.00	33.00	30.00	30028 
	stainless steel	1022 x 442 x 80*	150.00	33.00	30.00	30064 
 Tray shelf metal-free	PP grey	888 x 415 x 107*	50.00	33.00	30.00	30027 
 Grid as storage level	steel galvanised	1036 x 450 x 30	180.00			27566 
Perforated insert						
 Perforated insert height = 135 mm	sheet steel powder-coated RAL 7035	1004 x 422 x 135	135.00			14084 
	stainless steel	1024 x 417 x 60	75.00			5536 
 Perforated insert	sheet steel powder-coated RAL 7035	1024 x 417 x 60	75.00			5773 
	stainless steel	1024 x 417 x 60	75.00			5773 
Bottom collecting sump						
 Bottom collecting sump	sheet steel powder-coated RAL 7035	1025 x 445 x 80*		33.00	30.00	33634 
	stainless steel	1025 x 445 x 80*		33.00	30.00	33641 
 Bottom collecting sump capacity 55.5 ltr	sheet steel powder-coated RAL 7035	1016 x 439 x 130*		55.00	50.00	33639 
	stainless steel	1022 x 442 x 122*		55.50	50.45	30026 
 Bottom collecting sump metal-free	PP grey	888 x 415 x 111*		33.00	30.00	33830 
Drawer						
 Drawer	sheet steel powder-coated RAL 7035	844 x 488 x 90*	60.00	29.00	26.36	30031 
	stainless steel	844 x 488 x 90*	60.00	29.00	26.36	30033 
 Drawer (heavy duty)	sheet steel powder-coated RAL 7035	843 x 487 x 162*	100.00	66.00	60.00	30032 
	stainless steel	843 x 487 x 162*	100.00	66.00	60.00	30034 
Accessories						
 Storage box left hinged	sheet steel powder-coated RAL 7035	380 x 420 x 360				30029 
 Storage box right hinged	sheet steel powder-coated RAL 7035	380 x 420 x 360				30030 
 Sump inliner for shelf	PE black	1000 x 392 x 50*		18.00	16.36	7223 
 Sump inliner for drawer	PP grey	834 x 450 x 96*		33.50	30.45	10054 
 Anti-slip rubber mat for drawer	black	840 x 490 x 1				8699 
 Pipe lead-through	sheet steel powder-coated RAL 7035	182 x 104 x 48				30035 
 Box for chemicals	PP blue	410 x 300 x 260				30038 
 Document holder DIN A5	polystyrene					30793 

 Ventilation	Order No.
Recirculating air filter system with exhaust air monitoring	25099 
Extraction unit with exhaust air monitoring	14220 
Extraction unit without exhaust air monitoring	14218 

* usable storage space W x D (mm)

1) load capacity (kg), 2) retention capacity (ltr), 3) maximum container volume in the cabinet (ltr)

PLEASE NOTE:
drawers are only available
in combination with
WDAS. cabinets



S-LINE

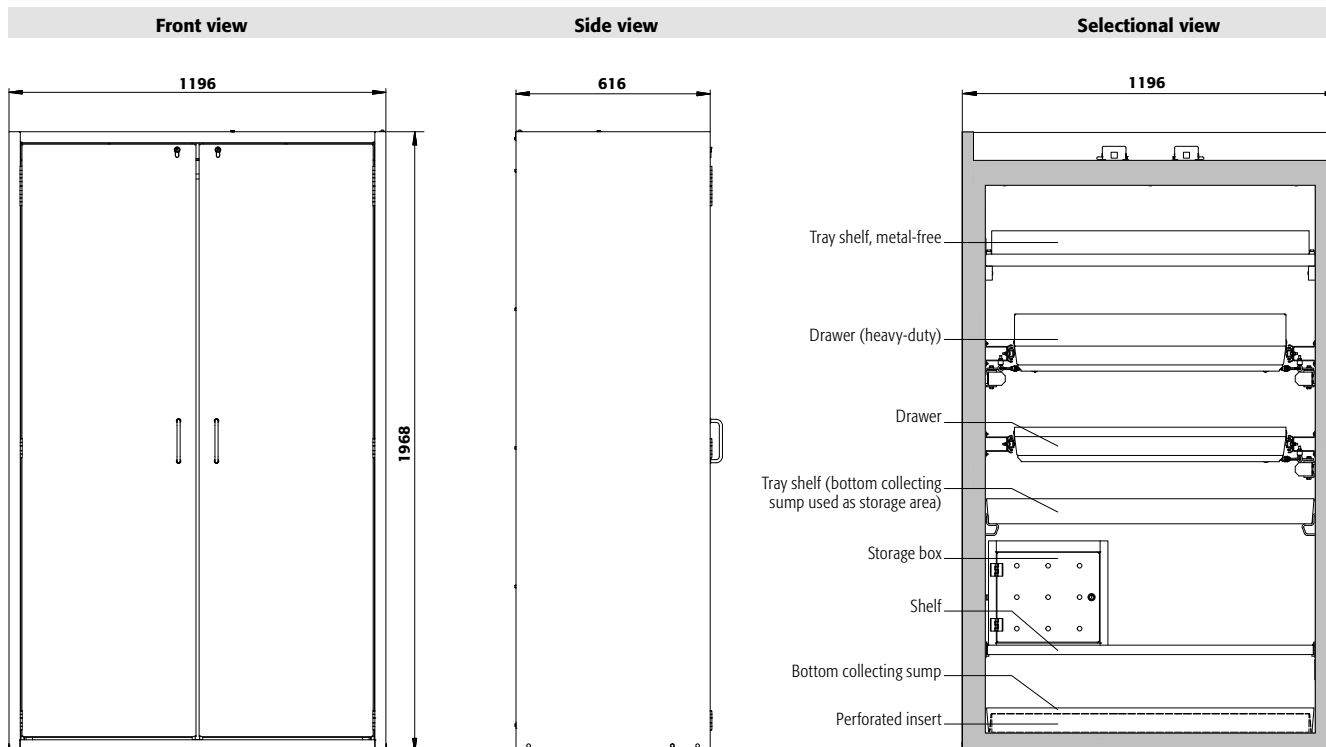

Technical data

S90.196.120(.WDAS)

External dimensions W x D x H	mm	1196 x 616 x 1968
Internal dimensions W x D x H	mm	1050 x 524 x 1742
Weight without interior equip.	kg	420
Air change 10 times	m ³ /h	10
Diff. pressure (air change 10 times EK5/AK4)	Pa	5
Diff. pressure (air change 10 times)	Pa	5
Maximum load	kg	600
Distributed load	kg/m ²	528
Transport base optional		
Entry height	mm	100
Entry width	mm	2 x 440

Top view

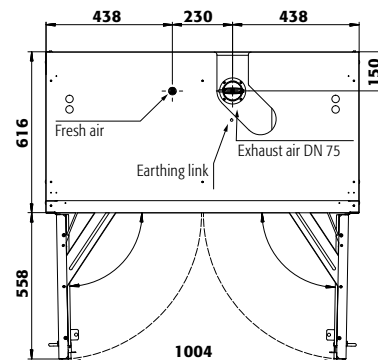

S90.196.120(.WDAS)

Drawers/number

	9	8	7	6	5	4+1	4	3+1	3	2
Distance ⑨ (mm)	145									
Distance ⑧ (mm)	135	210								
Distance ⑦ (mm)	135	200	210							
Distance ⑥ (mm)	170	200	200	275						
Distance ⑤ (mm)	170	170	200	230	340	295				
Distance ④ (mm)	170	170	200	230	330	295	400			
Distance ③ (mm)	170	170	200	230	295	230	360	530		
Distance ② (mm)	170	170	230	230	295	230	390	520	1010	
Distance ① (mm)	200	200	265	330	295	490	425	550	615	

S90.196.120(.WDAS)

Shelves/number

	4	3	2
Distance ④ (mm)	460		
Distance ③ (mm)	280	490	
Distance ② (mm)	315	380	
Distance ① (mm)	315	410	

S90.196.120(.WDAS)

Quantity

Quantity	Type of container	Container size
90	Aerosol cans	400 ml
40	Cans	1 litre
40	Laboratory glass bottles	1 litre
40	Laboratory PE-bottles	1 litre
15	Laboratory glass bottles	2.5 litres

