

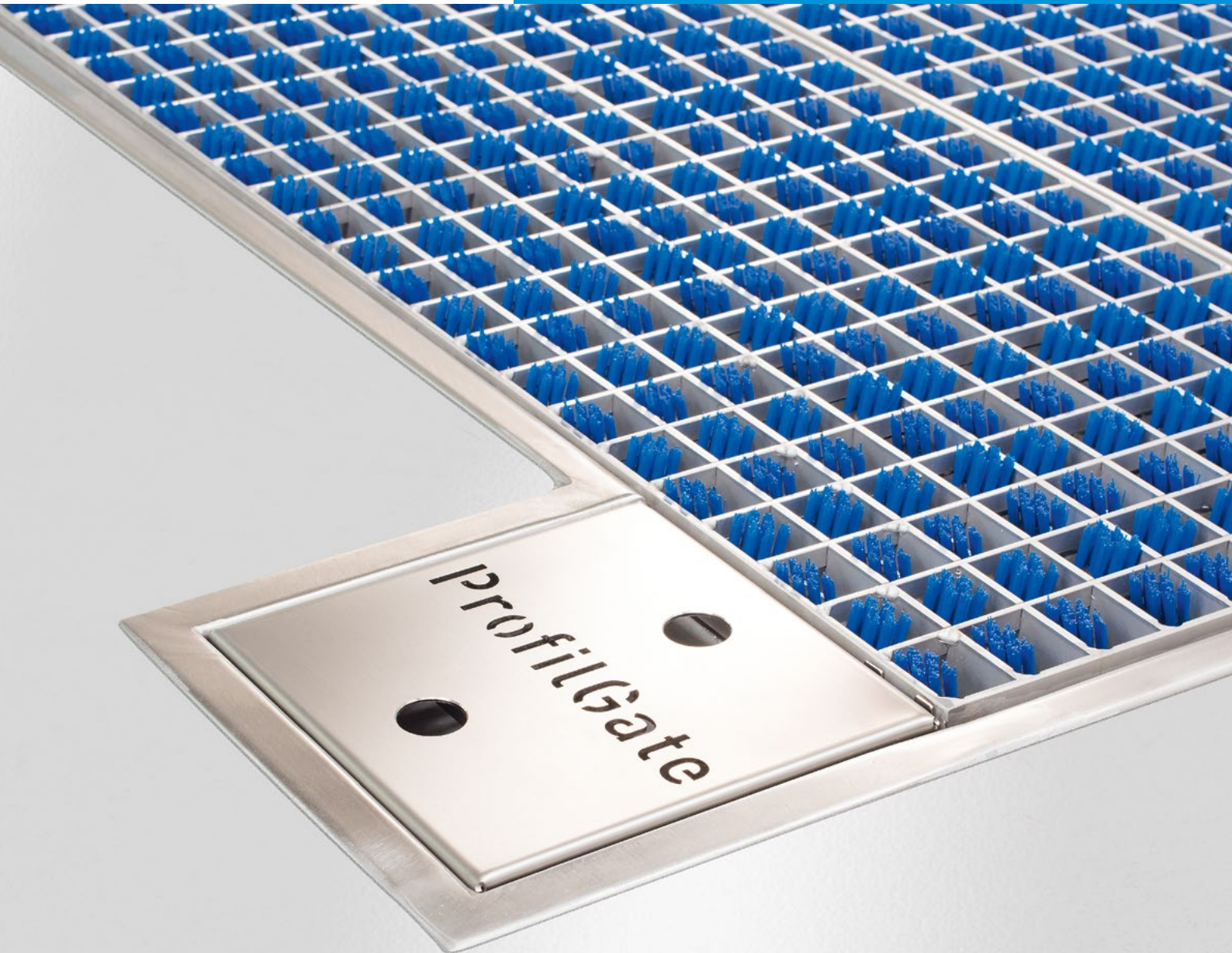

ProfilGate®

ProfilGate® aqua – design variations



A product of



ProfilGate® aqua – design variations

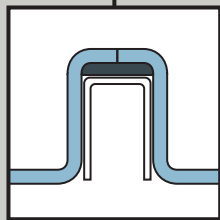

Tray combinations

Depending on the size of the desired ProfilGate® aqua cleaning field, a single tray or a combination of trays is applied (page 4).

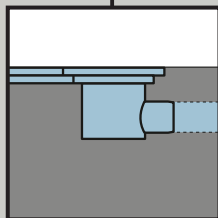

Drain, type A

Sideward drain for laying the drain-pipe in the floor (page 5)

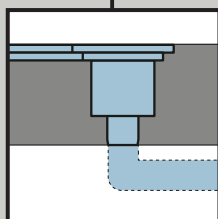

Drain, type B

Downward drain for laying through the floor/ceiling (page 5)

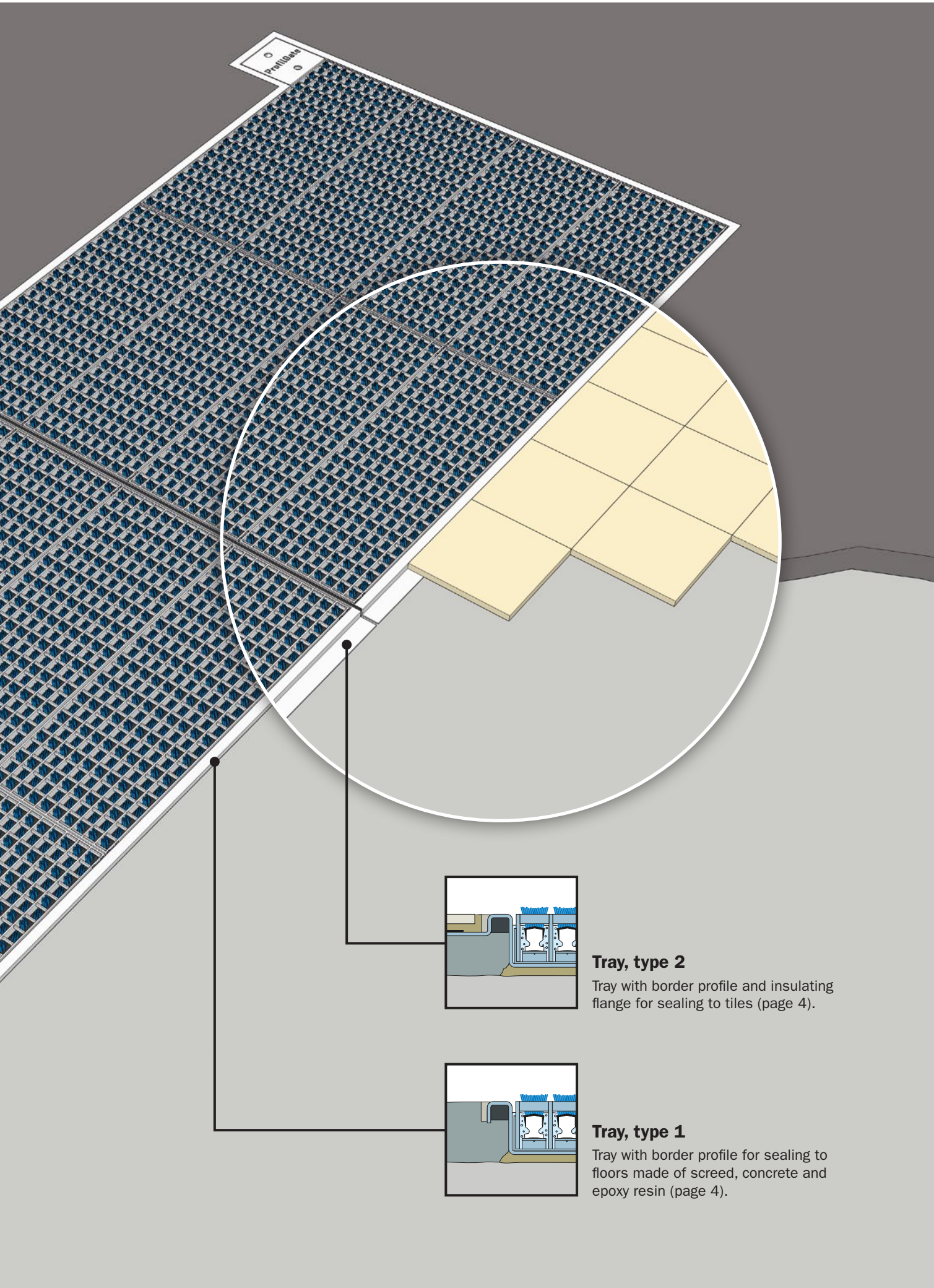

ProfilGate

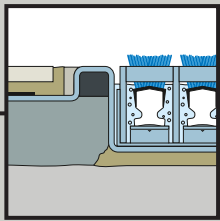

Tray, type 2
Tray with border profile and insulating flange for sealing to tiles (page 4).

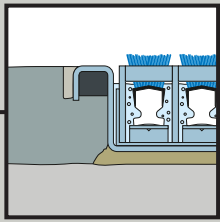

Tray, type 1
Tray with border profile for sealing to floors made of screed, concrete and epoxy resin (page 4).

Tray type

Depending on the type of floor covering, the appropriate tray type has to be selected to assure reliable and durable sealing when installing.

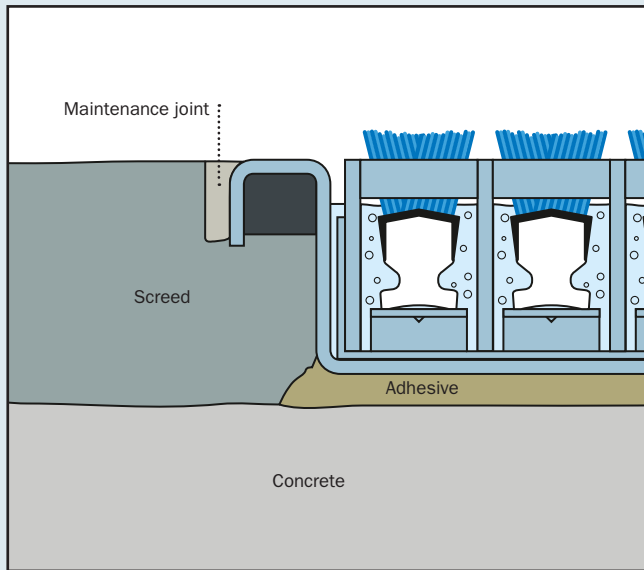

Tray, type 1

This tray type with border profile lends itself for installation in floors made from screed, concrete and epoxy resin.

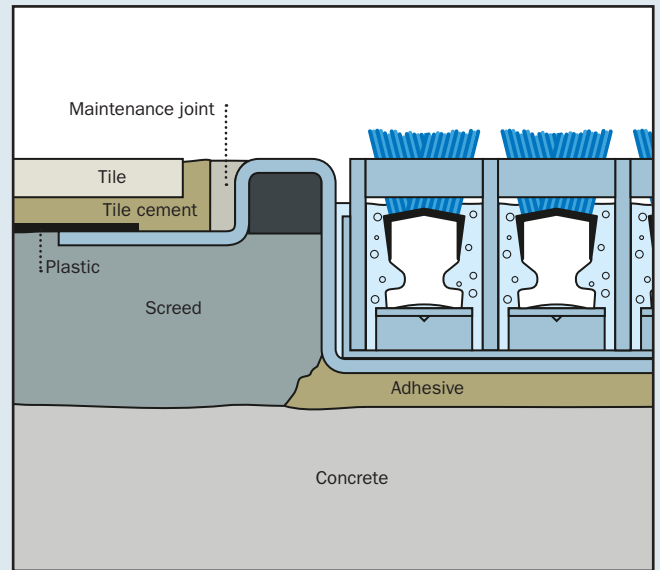

Tray, type 2

This tray type with border profile and insulating flange is suited for installation in tiled floors. A flat sealing sheet can be fixed on the insulating flange.

Single tray / tray combinations

Single tray

Single trays are deliverable up to size 1,829 mm in width to 2,967 mm in length (driving direction).

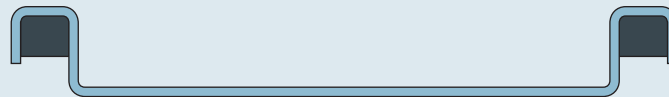

Single tray

Figure and dimensions refer to the tray type 1.

2 combined trays

As for a larger cleaning field, two trays have to be combined, each of them equipped with one special joining flange on one side (**connecting trays**).



Connecting tray

Connecting tray

The figure refers to the tray type 1.

3 and more combined trays

Regarding the combination of 3 or more trays, both the first tray and the last one must be equipped with a joining flange (**connecting trays**). Each tray installed in between needs to have the joining flange on both sides (**intermediate trays**).



Connecting tray

Intermediate tray

Connecting tray

The figure refers to the tray type 1.

Drain type

Drain, type A - sideward

This drain type is suitable for drain pipes laid in the floor. The direction of the joining pipe can be selected in steps of 90° each.

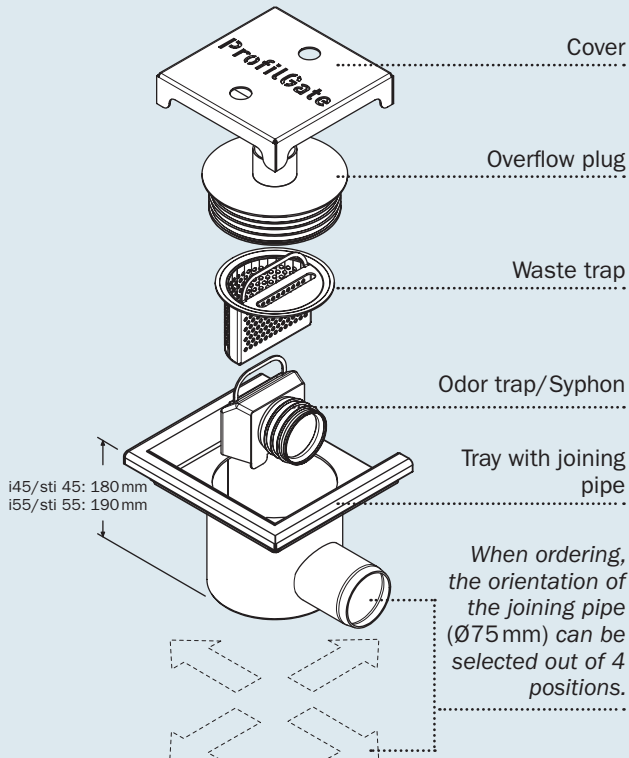

Drain, type B - downward

This drain type is appropriate for installation through floors and ceilings. At first, the gully with its adhesive flange is glued into the floor borehole. Then the connecting pipe with seal of the tray is fitted in. Dirt bucket and standpipe make up the odor trap.

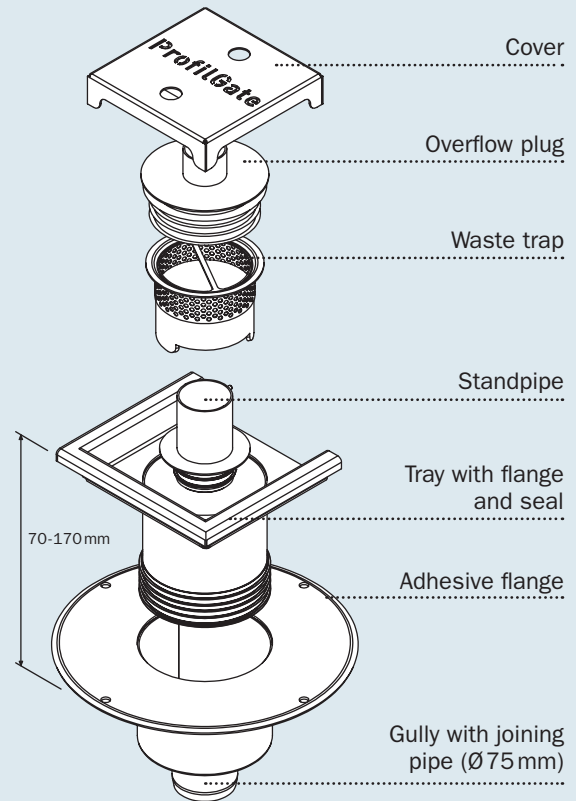

Draining position

Each tray is individually customised. This is particularly true for the drain position. The drain cannot be re-located later as it forms integral part of the tray.

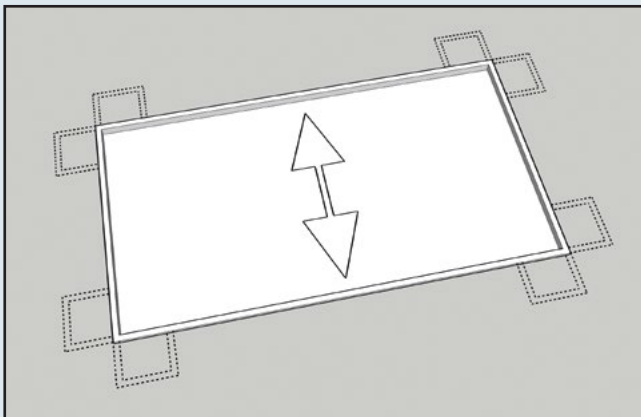

Standard drain positions



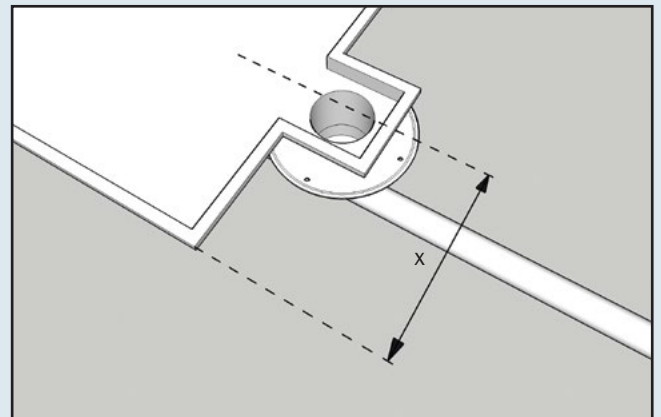



The drawing depicts eight possible standard drain positions. The driving direction has to be defined in advance since it determines the location of the segments and alignment of the grates with the brush strips.

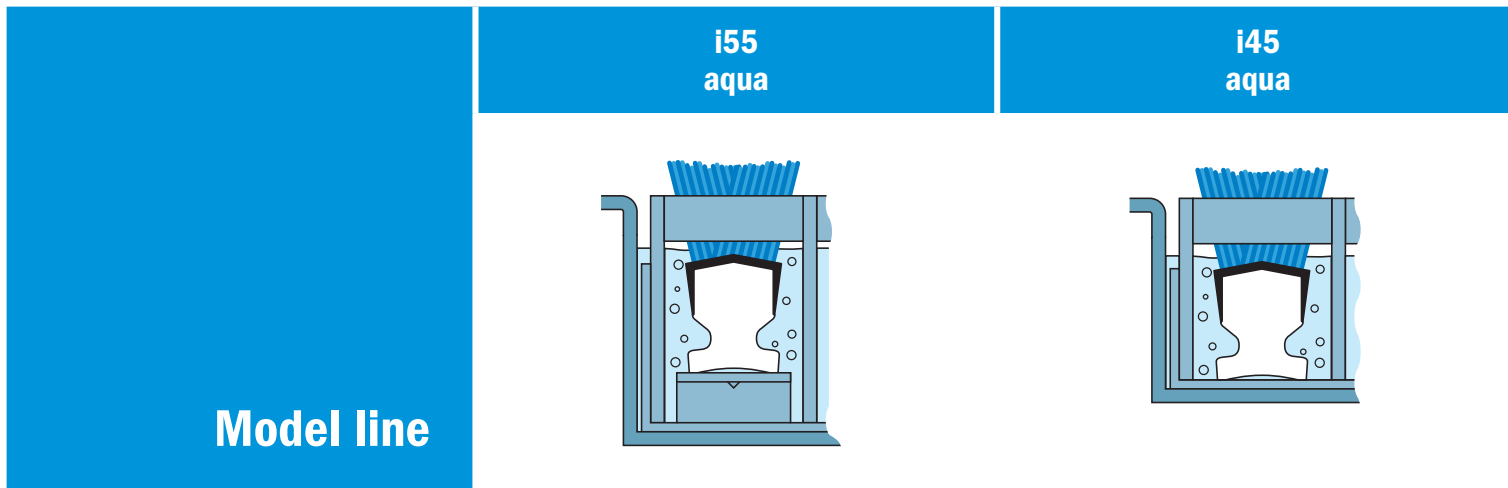

Individual offset of the drain

Starting from one of the standard positions, the drain can be shifted as required. The position as required enables connecting the drain to an existing waste water pipe.







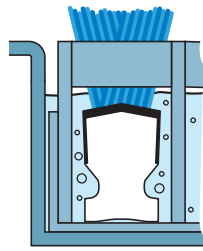
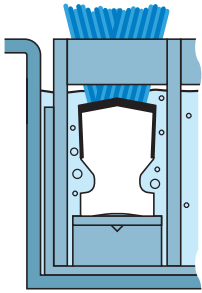

Tray height (mm) 	55			45		
Extra dirt / water reservoir (mm)	+10			-		
Optimum for						
Maximum admissible vehicle weight (t) 	20			10		
Suitable for hard rollers 	-			-		
Appropriate roller width (mm) 	≥31			≥31		
Grate Stainless steel V2A (1.4301)	●			●		
Tray Stainless steel V2A (1.4301)	●			●		
Brush strips per grate	10			10		
Grates per segment	2			2		
Module format (number of segments W x L)	1,5 x 1	1 x 2	3 x 2	1,5 x 1	1 x 2	3 x 2
Tray size, type 1 (W x L in mm)	1115 x 1026	764 x 1995	2177 x 1995	1119 x 1026	764 x 1997	2183 x 1997
Tray size, type 2 (W x L in mm)	1209 x 1120	858 x 2089	2271 x 2089	1213 x 1120	858 x 2091	2277 x 2091
Number of grates x weight	3 x 26 kg	4 x 26 kg	12 x 26 kg	3 x 21 kg	4 x 21 kg	12 x 21 kg
	2 x 1	1,5 x 2	1,5 x 3	2 x 1	1,5 x 2	1,5 x 3
	1470 x 1026	1115 x 1995	1115 x 2963	1473 x 1026	1119 x 1997	1119 x 2967
	1564 x 1120	1209 x 2089	1209 x 3057	1567 x 1120	1213 x 2091	1213 x 3061
	4 x 26 kg	6 x 26 kg	9 x 26 kg	4 x 21 kg	6 x 21 kg	9 x 21 kg
	2,5 x 1	2 x 2	2 x 3	2,5 x 1	2 x 2	2 x 3
	1824 x 1026	1470 x 1995	1470 x 2963	1829 x 1026	1473 x 1997	1473 x 2967
	1918 x 1120	1564 x 2089	1564 x 3057	1923 x 1120	1567 x 2091	1567 x 3061
	5 x 26 kg	8 x 26 kg	12 x 26 kg	5 x 21 kg	8 x 21 kg	12 x 21 kg
	3 x 1	2,5 x 2	2,5 x 3	3 x 1	2,5 x 2	2,5 x 3
	2177 x 1026	1824 x 1995	1824 x 2963	2183 x 1026	1829 x 1997	1829 x 2967
	2271 x 1120	1918 x 2089	1918 x 3057	2277 x 1120	1923 x 2091	1923 x 3061
	6 x 26 kg	10 x 26 kg	15 x 26 kg	6 x 21 kg	10 x 21 kg	15 x 21 kg

sti55
aqua

sti45
aqua



Model line

55			45			Tray height (mm) 
+10			-			Extra dirt / water reservoir (mm)
						Optimum for
20			10			Maximum admissible vehicle weight (t) 
●			●			Suitable for hard rollers 
≥24			≥24			Appropriate roller width (mm) 
●			●			Grate Stainless steel V2A (1.4301)
●			●			Tray Stainless steel V2A (1.4301)
14			14			Brush strips per grate
2			2			Grates per segment
1,5 x 1 1115 x 1026 <i>1209 x 1120</i> 3 x 27 kg	1 x 2 764 x 1995 <i>858 x 2089</i> 4 x 27 kg	3 x 2 2177 x 1995 <i>2271 x 2089</i> 12 x 27 kg	1,5 x 1 1119 x 1026 <i>1213 x 1120</i> 3 x 23 kg	1 x 2 764 x 1997 <i>858 x 2091</i> 4 x 23 kg	3 x 2 2183 x 1997 <i>2277 x 2091</i> 12 x 23 kg	Module format (number of segments W x L) Tray size, type 1 (W x L in mm) <i>Tray size, type 2 (W x L in mm)</i> Number of grates x weight
2 x 1 1470 x 1026 <i>1564 x 1120</i> 4 x 27 kg	1,5 x 2 1115 x 1995 <i>1209 x 2089</i> 6 x 27 kg	1,5 x 3 1115 x 2963 <i>1209 x 3057</i> 9 x 27 kg	2 x 1 1473 x 1026 <i>1567 x 1120</i> 4 x 23 kg	1,5 x 2 1119 x 1997 <i>1213 x 2091</i> 6 x 23 kg	1,5 x 3 1119 x 2967 <i>1213 x 3061</i> 9 x 23 kg	
2,5 x 1 1824 x 1026 <i>1918 x 1120</i> 5 x 27 kg	2 x 2 1470 x 1995 <i>1564 x 2089</i> 8 x 27 kg	2 x 3 1470 x 2963 <i>1564 x 3057</i> 12 x 27 kg	2,5 x 1 1829 x 1026 <i>1923 x 1120</i> 5 x 23 kg	2 x 2 1473 x 1997 <i>1567 x 2091</i> 8 x 23 kg	2 x 3 1473 x 2967 <i>1567 x 3061</i> 12 x 23 kg	
3 x 1 2177 x 1026 <i>2271 x 1120</i> 6 x 27 kg	2,5 x 2 1824 x 1995 <i>1918 x 2089</i> 10 x 27 kg	2,5 x 3 1824 x 2963 <i>1918 x 3057</i> 15 x 27 kg	3 x 1 2183 x 1026 <i>2277 x 1120</i> 6 x 23 kg	2,5 x 2 1829 x 1997 <i>1923 x 2091</i> 10 x 23 kg	2,5 x 3 1829 x 2967 <i>1923 x 3061</i> 15 x 23 kg	



www.profilgate.com

Subject to technical modifications. The colours printed in this catalogue may deviate from the original ones. - PPGA01 - EN - 11-2017



Höhscheider Weg 37 · 42699 Solingen · Germany
Tel.: +49(0)212-380 310 · Fax: +49(0)212-380 31 39
info@heute-gmbh.de · info@profilgate.com

www.heute-gmbh.de · www.profilgate.com

