



**Combi safety storage cabinets**  
**K-PHOENIX-90 model K90.196.120.MF.FWAS**  
light grey (RAL 7035), interior equipment with 3 x shelf, 1 x perforated insert, 1 x bottom collecting sump (sheet steel powder-coated), 4 x pull-out shelf (panel melamine resin-coated/PP)  
**Order No. 30333-001-33838**

**Left compartment**



**Right compartment**



**Safe and approved storage of aggressive and flammable hazardous substances in working areas**

**Function / construction:**

- **Robust construction and longevity:** triple hinged door, body made of powder-coated sheet steel, safety elements assembled outside the cabinet for increased protection against corrosion
- **Two in one:** 2 compartments (vertical separated) allow the storage of flammable liquids and aggressive chemicals in one cabinet
- **User-friendly and safe (folding door compartment):** door open arrest system (standard), convenient and safe removal or storage of containers
- **No unauthorised use:** doors lockable with profile cylinder (integration in an existing locking system possible) / cylinder lock
- **Easy alignment:** adjusting aids to compensate for uneven floor

- **Ventilation:** integrated air ducts ready for connection (DN 75) to a technical exhaust system

**Available equipment:**

- Compartment for the storage of flammable liquids
  - Drawers – high storage capacity, optimal use of the available storage capacities
  - Sump inliner (PE or PP)
  - Shelves with load capacity of 75 kg
  - Storage box
  - Perforated insert useable as storage area
  - Metal-free tray shelves and collecting sumps
  - Tray shelves with load capacity of 150 kg
  - Bottom collecting sump
- Compartment for the storage of aggressive, non flammable hazardous materials
- Pull-out shelves with removable plastic sump

**Explore our media service ...**  
... visit [www.asecos-specs.com](http://www.asecos-specs.com) for technical specifications, CAD drawings, BIM content and certificates on our products.

**Drawer**  
Sturdy construction with removable plastic sump

**Shelf**  
Height adjustable (32 mm increments), with 30 mm upstand

**Bottom collecting sump**  
High storage capacity, optimal for the storage of larger containers, safe collection of leakages

**Extraction unit**  
Safe ventilation of safety storage cabinets  
Plug-in – fast and easy to install  
Further information and products from page 505  
**Order No. 14218**

**The asecos HazMat Guide**  
... we have collected the most important information on storing and handling hazardous materials safely.  
Order your free copy now:  
[www.asecos.global](http://www.asecos.global)



**Combi safety storage cabinets**

**K-PHOENIX-90 model K90.196.120.MF.FWAS**

light grey (RAL 7035), interior equipment with 6 x drawer (sheet steel powder-coated), 6 x pull-out shelf (panel melamine resin-coated/PP)

**Order No. 30333-001-33839**

(extraction unit optional)

**Combi safety storage cabinets**

**K-PHOENIX-90 model K90.196.120.MC.FWAS**

light grey (RAL 7035), interior equipment with 1 x storage box, 2 x shelf, 1 x perforated insert, 1 x bottom collecting sump (sheet steel powder-coated), 4 x pull-out shelf (panel melamine resin-coated/PP)

**Order No. 30335-001-33841**

Available colours:



001 005

Order example - how to order correctly



30333 - 001 - 33838

Model	Information / equipment	Order No.
K90.196.120.MF.FWAS	without interior equipment, with door open arrest system, with vertical centre partition (fire resistant)	30333
K90.196.120.MC.FWAS	without interior equipment, with door open arrest system, hazardous substances center (including lockable storage box on shelf)	30335

Body colour	Door colour	Order No.
Light grey RAL 7035	light grey RAL 7035	001
Laboratory white (sim. RAL 9016)	laboratory white (sim. RAL 9016)	005



















































Interior equipment packages (can only be ordered in combination with the cabinet)	Material	Order No.
<b>K90.196.120.MF.FWAS</b>		
Left: 3x shelf, 1x perforated insert, 1x bottom collecting sump (V=22.0L) Top right: 2x pull-out shelf (V=11.0L) Bottom right: 2x pull-out shelf (V=11.0L)	sheet steel powder-coated RAL 7035, panel melamine resin-coated/PP grey	33838
Left: 3x shelf, 1x perforated insert, 1x bottom collecting sump (V=22.0L) Top right: 2x pull-out shelf (V=11.0L) Bottom right: 2x pull-out shelf (V=11.0L)	stainless steel, panel melamine resin-coated/PP grey	30338
Left: 6x drawer (V=4.5L) Top right: 3x pull-out shelf (V=11.0L) Bottom right: 3x pull-out shelf (V=11.0L)	sheet steel powder-coated RAL 7035, panel melamine resin-coated/PP grey	33839
Left: 6x drawer (V=4.5L) Top right: 3x pull-out shelf (V=11.0L) Bottom right: 3x pull-out shelf (V=11.0L)	stainless steel, panel melamine resin-coated/PP grey	33840
<b>K90.196.120.MC.FWAS</b>		
Left: 1x storage box, 2x shelf, 1x perforated insert, 1x bottom collecting sump (V=22.0L) Top right: 2x pull-out shelf (V=11.0L) Bottom right: 2x pull-out shelf (V=11.0L)	sheet steel powder-coated RAL 7035, panel melamine resin-coated/PP grey	33841
Left: 1x storage box, 2x shelf, 1x perforated insert, 1x bottom collecting sump (V=22.0L) Top right: 2x pull-out shelf (V=11.0L) Bottom right: 2x pull-out shelf (V=11.0L)	stainless steel, panel melamine resin-coated/PP grey	30755
Left: 1x storage box, 4x drawer (V=4.5L) Top right: 3x pull-out shelf (V=11.0L) Bottom right: 3x pull-out shelf (V=11.0L)	sheet steel powder-coated RAL 7035, panel melamine resin-coated/PP grey	33842
Left: 1x storage box, 4x drawer (V=4.5L) Top right: 3x pull-out shelf (V=11.0L) Bottom right: 3x pull-out shelf (V=11.0L)	stainless steel, panel melamine resin-coated/PP grey	33843







## Individual configuration of model **K90.196.120.MF(MC).FWAS**

 Model	Information / equipment	W x D x H (mm)	Order No.
K90.196.120.MF.FWAS	without interior equipment, with door open arrest system, with vertical centre partition (fire resistant)	1197 x 617 x 1969	30333
K90.196.120.MC.FWAS	without interior equipment, with door open arrest system, hazardous substances center (including lockable storage box on shelf)	1197 x 617 x 1969	30335

 Body colour	Door colour	Order No.
Light grey RAL 7035	light grey RAL 7035	001 
Laboratory white (sim. RAL 9016)	laboratory white (sim. RAL 9016)	005 

 Interior equipment individual parts (left comp.)	Material	W x D x H (mm)	 <sup>1)</sup>	 <sup>2)</sup>	 <sup>3)</sup>	Order No.
<b>Shelf</b>						
	Shelf	sheet steel powder-coated RAL 7035	440 x 432 x 30*	75.00		30098 
		stainless steel	440 x 432 x 30*	75.00		30102 
	Tray shelf	sheet steel powder-coated RAL 7035	427 x 442 x 70*	150.00	11.50 10.45	30099 
		stainless steel	427 x 442 x 70*	150.00	11.50 10.45	30103 
	Tray shelf metal-free	PP grey	370 x 417 x 89*	50.00	11.00 10.00	30106 
<b>Perforated insert</b>						
	Perforated insert	sheet steel powder-coated RAL 7035	420 x 439 x 60	75.00		5555 
		stainless steel	420 x 439 x 60	75.00		5776 
	Perforated insert height = 180 mm	sheet steel powder-coated RAL 7035	438 x 453 x 180	75.00		17693 
	Perforated insert height = 170 mm	stainless steel	438 x 453 x 170	75.00		10254 
<b>Bottom collecting sump</b>						
	Bottom collecting sump	sheet steel powder-coated RAL 7035	442 x 457 x 130	22.00	20.00	33594 
		stainless steel	415 x 480 x 127*	22.00	20.00	30104 
	Bottom collecting sump height = 180 mm	sheet steel powder-coated RAL 7035	439 x 454 x 180*	33.00	30.00	33605 
	Bottom collecting sump height = 170 mm	stainless steel	439 x 504 x 171*	33.00	30.00	30105 
	Bottom collecting sump metal-free	PP grey	449 x 505 x 94	11.00	10.00	33828 
<b>Drawer</b>						
	Drawer	sheet steel powder-coated RAL 7035	345 x 500 x 50*	25.00	4.50 4.09	30108 
		stainless steel	345 x 500 x 50*	25.00	4.50 4.09	30110 
	Drawer (disposal)	sheet steel powder-coated RAL 7035	329 x 502 x 50*	50.00	7.50 6.82	30109 
		stainless steel	329 x 502 x 50*	50.00	7.50 6.82	30111 
<b>Accessories</b>						
	Storage box left hinged	sheet steel powder-coated RAL 7035	380 x 420 x 360			30029 
	Storage box right hinged	sheet steel powder-coated RAL 7035	380 x 420 x 360			30030 
	Sump inliner	PP grey	353 x 406 x 88*	11.50	10.45	9706 
	Sump inliner for drawer disposal	PP black	313 x 413 x 175*	18.50	16.82	18474 
	Sump inliner for drawer	PP undyed	318 x 449 x 66*	8.50	7.73	18472 
	Anti-slip rubber mat for drawer supply	black	495 x 340 x 1			8719 
	Pipe lead-through	sheet steel powder-coated RAL 7035	182 x 104 x 48			30035 
	Box for chemicals	PP blue	410 x 300 x 260			30038 
	Document holder DIN A5	polystyrene				30793 

 Interior equipment individual parts (right comp.)	Material	W x D x H (mm)	 <sup>1)</sup>	 <sup>2)</sup>	 <sup>3)</sup>	Order No.
<b>Pull-out shelf</b>						
	Pull-out shelf with PP-sump	panel melamine resin-coated/PP grey	407 x 468 x 80*	25.00	11.00 10.00	30770 

 Ventilation	Order No.
Extraction unit without exhaust air monitoring	14218 

\* usable storage space W x D (mm)

1) load capacity (kg), 2) retention capacity (ltr), 3) maximum container volume in the cabinet (ltr)

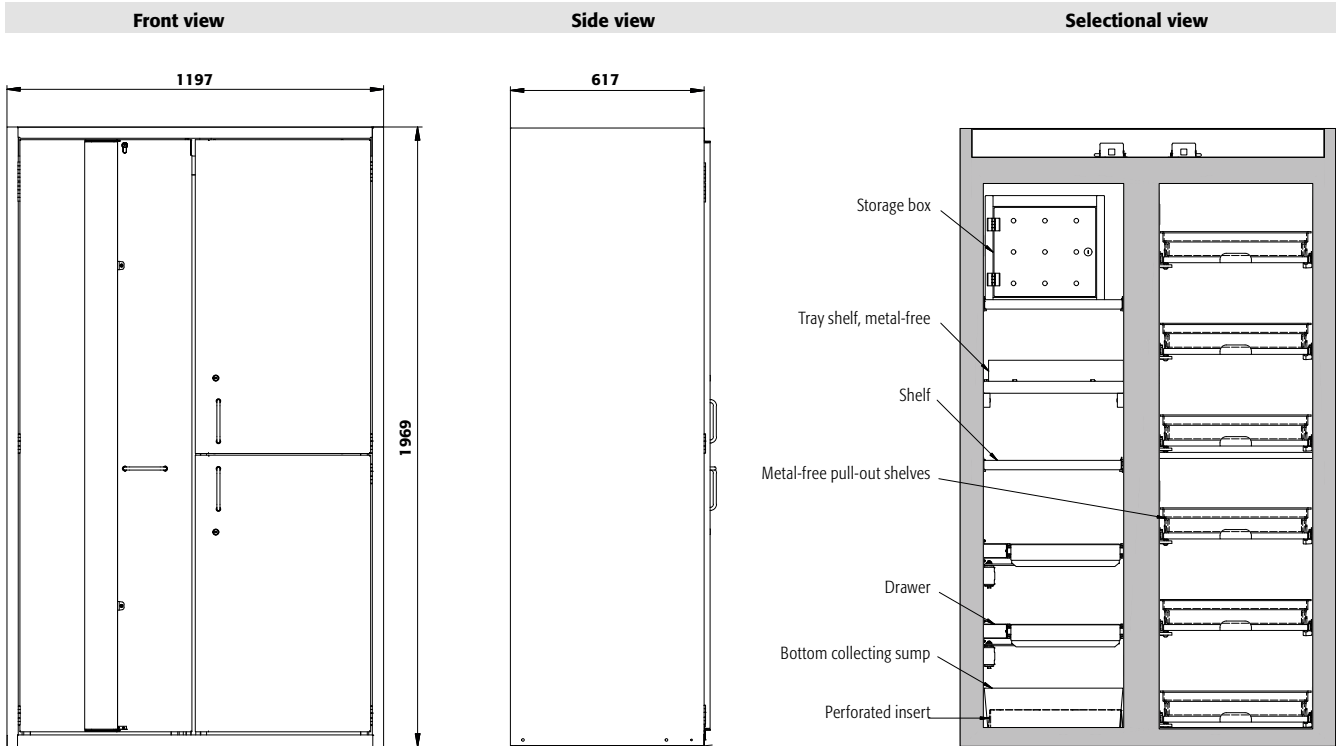

**Technical data**

**K90.196.120.MF(MC).FWAS**

External dimensions W x D x H	mm	1197 x 617 x 1969
Internal dimensions W x D x H	mm	left: 450 x 522 x 1742 top right: 491 x 542 x 862 bottom right: 491 x 542 x 862
Weight without interior equip.	kg	515
Air change <b>10 times</b>	m <sup>3</sup> /h	9
Diff. pressure (air change <b>10 times EK5/AK4</b> )	Pa	5
Diff. pressure (air change <b>10 times</b> )	Pa	5
Maximum load	kg	600
Distributed load	kg/m <sup>2</sup>	576
<b>Transport base optional</b>		
Entry height	mm	100
Entry width	mm	2 x 440

**Top view**

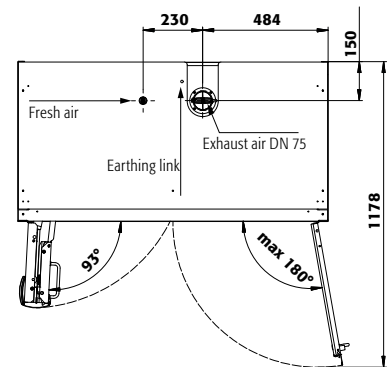

**Standard storage heights for drawers (left compartment)**

K90.196.120.MF(MC).FWAS	MF											MC
Drawers/number	9	8	7	6	5	4+1	4	3+1	3	2	4	
Distance ⑨ (mm)												
Distance ⑧ (mm)												
Distance ⑦ (mm)												
Distance ⑥ (mm)												
Distance ⑤ (mm)												
Distance ④ (mm)							255				385	
Distance ③ (mm)							295				390	
Distance ② (mm)							295				390	
Distance ① (mm)							295				390	

**Standard storage heights for shelves (left compartment)**

K90.196.120.MF(MC).FWAS	MF				MC
Shelves/number	4	3	2	3	
Distance ④ (mm)					
Distance ③ (mm)					
Distance ② (mm)		435		435	
Distance ① (mm)		380	445	380	
		410	410	410	

**Standard storage heights for pull-out shelves (right compartment)**

K90.196.120.MF(MC).FWAS	MF			MC
Pull-out shelves/number	6	4		
Distance ⑥ (mm)	230			
Distance ⑤ (mm)	265			
Distance ④ (mm)	265	395		
Distance ③ (mm)	230	395		
Distance ② (mm)	265	395		
Distance ① (mm)	265	395		

