



**Safety storage cabinet**

**Q-CLASSIC-90 model Q90.195.090**

body colour anthracite grey (RAL 7016), with wing doors in warning yellow (RAL 1004), interior equipment with 3 x shelf, 1 x perforated insert, 1 x bottom collecting sump (sheet steel powder-coated)

**Order No. 30041-040-33622**

(base cover and extraction unit optional)



**Safe and approved storage of flammable hazardous substances in working areas**

**Function / construction:**

- **Robust construction and longevity:** triple hinged door, safety elements assembled outside the storage compartment for increased protection against corrosion, scratch- and impact-resistant surface, easy to clean
- **Easy handling with comfort:** doors stop in any position, self-closing in the event of fire
- **No unauthorised use:** doors lockable with cylinder locking (integration in an existing locking system possible) and locking state indicator (red/green)
- **Easy transport:** integrated transport base with removable, optional base cover
- **Easy alignment:** adjusting aids to compensate for uneven floor

- **Ventilation:** integrated air ducts ready for connection (DN 75) to a technical exhaust system, spinning wheel in the exhaust grid as an indicator of sufficient technical ventilation

**Available equipment:**

- Drawers – high storage capacity, optimal use of the available storage capacities
- Sump inliner (PE or PP)
- Shelves with load capacity of 75 kg
- Storage box
- Perforated insert useable as storage area
- Metal-free tray shelves and collecting sumps
- Drawers heavy-duty with load capacity of 100 kg
- Tray shelves with load capacity of 150 kg
- Bottom collecting sump



**Are you looking for a comfortable storage solution for your hazardous material containers?**

Operate two doors with one hand!



For PEGASUS safety storage cabinets see page 98



**Shelf**

Height adjustable (32 mm increments), with 30 mm upstand



**Extraction unit**

Safe ventilation of safety storage cabinets

Plug-in – fast and easy to install

Further information from page 505

**Order No. 14218**



**Drawers**

High storage capacity  
Ideal for the storage of small containers



**Metal-free interior equipment**

Ideal for the storage of flammable, aggressive hazardous substances. Tray shelves with chemical resistant surface lamination and removeable plastic sump, bottom collecting plastic sump.

**Recirculating air filter system**

Avoid complex wall break-throughs and expensive extraction piping  
Further information from page 500



**Order No. 25099**



**Safety storage cabinet**  
**Q-CLASSIC-90 model Q90.195.090**  
 body colour anthracite grey (RAL 7016), with wing doors in gentian blue (RAL 5010), interior equipment with 4 x drawer (sheet steel powder-coated)  
**Order No. 30041-047-33627**   
 (base cover optional)



**Safety storage cabinet**  
**Q-CLASSIC-90 model Q90.195.090**  
 body colour anthracite grey (RAL 7016), with wing doors in light grey (RAL 7035), interior equipment with 6 x drawer (sheet steel powder-coated)  
**Order No. 30041-041-33629**   
 (base cover optional)





7 door colours are available at no extra cost:



















Order example - how to order correctly



|  | without interior equipment | Information / equipment    | Order No. |
|---|----------------------------|----------------------------|-----------|
|   | Q90.195.090                | without interior equipment | 30041     |

|  | Body colour              | Door colour             | Order No.   |
|---|--------------------------|-------------------------|---|
|   | Anthracite grey RAL 7016 | warning yellow RAL 1004 | 040  |
|   | Anthracite grey RAL 7016 | light grey RAL 7035     | 041  |
|   | Anthracite grey RAL 7016 | traffic red RAL 3020    | 046  |
|   | Anthracite grey RAL 7016 | gentian blue RAL 5010   | 047  |
|   | Anthracite grey RAL 7016 | reseda green RAL 6011   | 048  |
|   | Anthracite grey RAL 7016 | asecos silver           | 049  |
|   | Anthracite grey RAL 7016 | pure white RAL 9010     | 050  |

|  | Interior equipment packages<br>(can only be ordered in combination with the cabinet) | Material                           | Order No.   |
|---|--|------------------------------------|---|
|   | 3x shelf, 1x perforated insert, 1x bottom collecting sump [V=22.0L]                  | sheet steel powder-coated RAL 7035 | 33622  |
|   | 4x shelf, 1x perforated insert, 1x bottom collecting sump [V=22.0L]                  | sheet steel powder-coated RAL 7035 | 33623  |
|   | 3x shelf, 1x bottom collecting sump [V=22.0L]  | sheet steel powder-coated RAL 7035 | 33624  |
|   | 4x shelf, 1x bottom collecting sump [V=22.0L]  | sheet steel powder-coated RAL 7035 | 33625  |
|   | 3x shelf, 1x perforated insert, 1x bottom collecting sump [V=22.0L]                  | stainless steel                    | 30047  |
|   | 4x shelf, 1x perforated insert, 1x bottom collecting sump [V=22.0L]                  | stainless steel                    | 30048  |
|   | 3x shelf, 1x bottom collecting sump [V=22.0L]  | stainless steel                    | 30049  |
|   | 4x shelf, 1x bottom collecting sump [V=22.0L]  | stainless steel                    | 30050  |
|   | 3x tray shelf [V=22.0L], 1x bottom collecting sump [V=22.0L]                         | PP grey                            | 30051  |
|   | 4x tray shelf [V=22.0L], 1x bottom collecting sump [V=22.0L]                         | PP grey                            | 30052  |
|   | 4x drawer [V=19.0L]  | sheet steel powder-coated RAL 7035 | 33627  |
|   | 5x drawer [V=19.0L]  | sheet steel powder-coated RAL 7035 | 33628  |
|   | 6x drawer [V=19.0L]  | sheet steel powder-coated RAL 7035 | 33629  |
|   | 4x drawer [V=19.0L]  | stainless steel                    | 33631  |
|   | 5x drawer [V=19.0L]  | stainless steel                    | 33632  |
|   | 6x drawer [V=19.0L]  | stainless steel                    | 33633  |



## Individual configuration of model Q90.195.090

| Model       | Information / equipment    | W x D x H (mm)   | Order No. |
|-------------|----------------------------|------------------|-----------|
| Q90.195.090 | without interior equipment | 893 x 615 x 1953 | 30041     |

| Body colour              | Door colour             | Order No. |
|--------------------------|-------------------------|-----------|
| Anthracite grey RAL 7016 | warning yellow RAL 1004 | 040       |
| Anthracite grey RAL 7016 | light grey RAL 7035     | 041       |
| Anthracite grey RAL 7016 | traffic red RAL 3020    | 046       |
| Anthracite grey RAL 7016 | gentian blue RAL 5010   | 047       |
| Anthracite grey RAL 7016 | reseda green RAL 6011   | 048       |
| Anthracite grey RAL 7016 | asecos silver           | 049       |
| Anthracite grey RAL 7016 | pure white RAL 9010     | 050       |

| Interior equipment                | Material                                    | W x D x H (mm)   | <sup>1)</sup> | <sup>2)</sup> | <sup>3)</sup> | Order No. |
|-----------------------------------|---|------------------|---------------|---------------|---------------|-----------|
| <b>Shelf</b>                      |   |                  |               |               |               |           |
| Shelf                             | sheet steel powder-coated RAL 7035          | 740 x 432 x 30*  | 75.00         |               |               | 30059     |
|                                   | stainless steel                             | 740 x 432 x 30*  | 75.00         |               |               | 30061     |
| Tray shelf                        | sheet steel powder-coated RAL 7035          | 725 x 445 x 80*  | 150.00        | 23.50         | 21.36         | 30828     |
|                                   | stainless steel                             | 723 x 488 x 83*  | 150.00        | 22.00         | 20.00         | 30829     |
| Tray shelf metal-free             | PP grey                                     | 644 x 416 x 102* | 50.00         | 22.00         | 20.00         | 30063     |
| <b>Perforated insert</b>          |   |                  |               |               |               |           |
| Perforated insert                 | sheet steel powder-coated RAL 7035          | 724 x 417 x 70   | 75.00         |               |               | 11165     |
|                                   | stainless steel                             | 724 x 417 x 70   | 75.00         |               |               | 11168     |
| <b>Bottom collecting sump</b>     |   |                  |               |               |               |           |
| Bottom collecting sump            | stainless steel                             | 723 x 488 x 83*  |               | 22.00         | 20.00         | 30062     |
|                                   | sheet steel powder-coated RAL 7035          | 725 x 445 x 80*  |               | 22.00         | 20.00         | 33621     |
| Bottom collecting sump metal-free | PP grey                                     | 749 x 505 x 107  |               | 22.00         | 20.00         | 33829     |
| <b>Drawer</b>                     |   |                  |               |               |               |           |
| Drawer                            | sheet steel powder-coated RAL 7035          | 544 x 488 x 90*  | 60.00         | 19.00         | 1727          | 30065     |
|                                   | stainless steel                             | 544 x 488 x 90*  | 60.00         | 19.00         | 1727          | 30067     |
| Drawer (heavy duty)               | sheet steel powder-coated RAL 7035          | 543 x 487 x 162* | 100.00        | 45.00         | 40.91         | 30066     |
|                                   | stainless steel                             | 543 x 487 x 162* | 100.00        | 45.00         | 40.91         | 30068     |
| <b>Accessories</b>                |   |                  |               |               |               |           |
| Storage box left hinged           | sheet steel powder-coated RAL 7035          | 380 x 420 x 360  |               |               |               | 30029     |
| Storage box right hinged          | sheet steel powder-coated RAL 7035          | 380 x 420 x 360  |               |               |               | 30030     |
| Sump inliner for drawer           | PP grey                                     | 534 x 450 x 96*  |               | 23.00         | 20.91         | 27948     |
| Sump inliner for shelf            | PP grey                                     | 653 x 406 x 88*  |               | 21.50         | 19.55         | 9707      |
| Anti-slip rubber mat for drawer   | black                                       | 540 x 490 x 1    |               |               |               | 15653     |
| Pipe lead-through                 | sheet steel powder-coated RAL 7035          | 182 x 104 x 48   |               |               |               | 30035     |
| Base cover                        | sheet steel powder-coated textured RAL 7016 | 818 x 35 x 85    |               |               |               | 30069     |
| Q-mover 2 pieces                  | steel powder-coated textured RAL 7016       | 600 x 140 x 130  |               |               |               | 30037     |
| Box for chemicals                 | PP blue                                     | 410 x 300 x 260  |               |               |               | 30038     |
| Document holder DIN A5            | polystyrene                                 |                  |               |               |               | 30793     |

| Ventilation   | Order No. |
|---|-----------|
| Recirculating air filter system with exhaust air monitoring | 25099     |
| Extraction unit without exhaust air monitoring              | 14218     |
| Extraction unit with exhaust air monitoring                 | 14220     |

\* usable storage space W x D (mm)  
 1) load capacity (kg), 2) retention capacity (ltr), 3) maximum container volume in the cabinet (ltr)

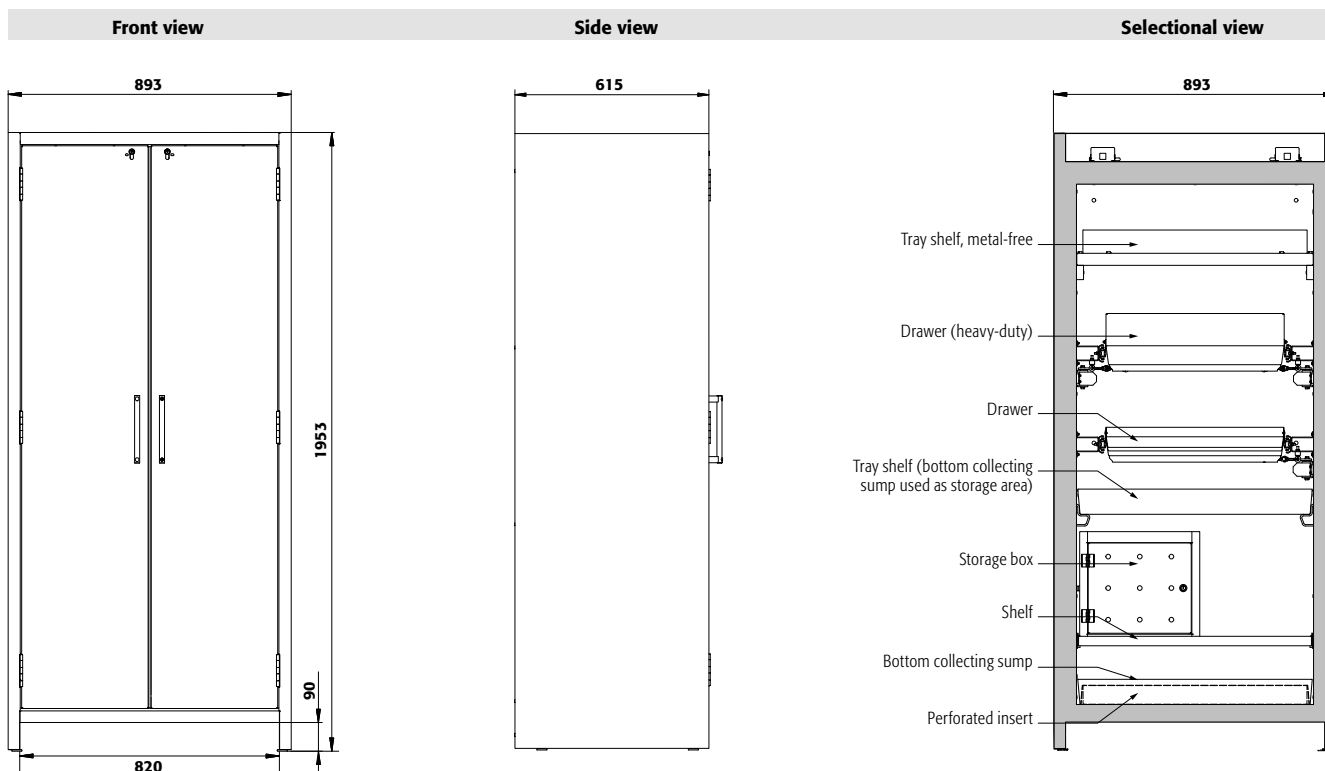

**Technical data**

**Q90.195.090**

|  |                   |                  |
|--|-------------------|------------------|
| External dimensions W x D x H                        | mm                | 893 x 615 x 1953 |
| Internal dimensions W x D x H                        | mm                | 750 x 522 x 1647 |
| Weight without interior equip.                       | kg                | 343              |
| Air change <b>10 times</b>                           | m <sup>3</sup> /h | 6                |
| Diff. pressure (air change <b>10 times</b> )         | Pa                | 5                |
| Diff. pressure (air change <b>10 times EK5/AK4</b> ) | Pa                | 5                |
| Maximum load   | kg                | 600              |
| Distributed load                                     | kg/m <sup>2</sup> | 654              |
| <b>Transport base</b>                                |                   |                  |
| Entry height transport base                          | mm                | 90               |
| Entry width transport base                           | mm                | 820              |

**Top view**

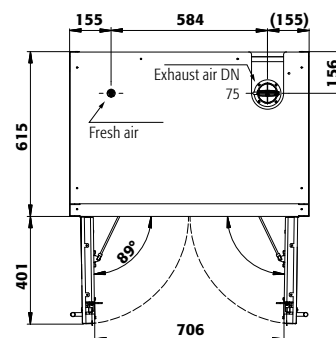

**Q90.195.090**

**Drawers/number**

|                 | <b>Standard storage heights of the drawers</b> |     |     |     |     |     |     |     |     |   |
|-----------------|--|-----|-----|-----|-----|-----|-----|-----|-----|---|
|                 | 9  | 8   | 7   | 6   | 5   | 4+1 | 4   | 3+1 | 3   | 2 |
| Distance ⑨ (mm) | 150  |     |     |     |     |     |     |     |     |   |
| Distance ⑧ (mm) | 135  | 150 |     |     |     |     |     |     |     |   |
| Distance ⑦ (mm) | 135  | 170 | 150 |     |     |     |     |     |     |   |
| Distance ⑥ (mm) | 135  | 170 | 200 | 250 |     |     |     |     |     |   |
| Distance ⑤ (mm) | 135  | 170 | 200 | 230 | 280 | 250 |     |     |     |   |
| Distance ④ (mm) | 135  | 170 | 200 | 230 | 295 | 230 | 345 |     |     |   |
| Distance ③ (mm) | 135  | 170 | 200 | 230 | 295 | 230 | 360 | 440 |     |   |
| Distance ② (mm) | 170  | 170 | 200 | 230 | 295 | 230 | 360 | 520 | 920 |   |
| Distance ① (mm) | 230  | 230 | 265 | 265 | 295 | 520 | 425 | 550 | 615 |   |

**Q90.195.090**

**Shelves/number**

|                 | <b>Standard storage heights of the shelves</b> |     |   |
|-----------------|--|-----|---|
|                 | 4  | 3   | 2 |
| Distance ④ (mm) | 370  |     |   |
| Distance ③ (mm) | 285  | 400 |   |
| Distance ② (mm) | 315  | 380 |   |
| Distance ① (mm) | 315  | 410 |   |

**Q90.195.090**

**Quantity**

|    | <b>Storage capacities per drawer/type of container</b> |                |
|----|--|----------------|
|    | Type of container                                      | Container size |
| 49 | Aerosol cans   | 400 ml         |
| 23 | Cans   | 1 litre        |
| 23 | Laboratory glass bottles                               | 1 litre        |
| 23 | Laboratory PE-bottles                                  | 1 litre        |
| 9  | Laboratory glass bottles                               | 2.5 litres     |

